

Technical Data Sheet

TYPE 600mm Ceramic Basin

Whats in the box: 1x TY6080

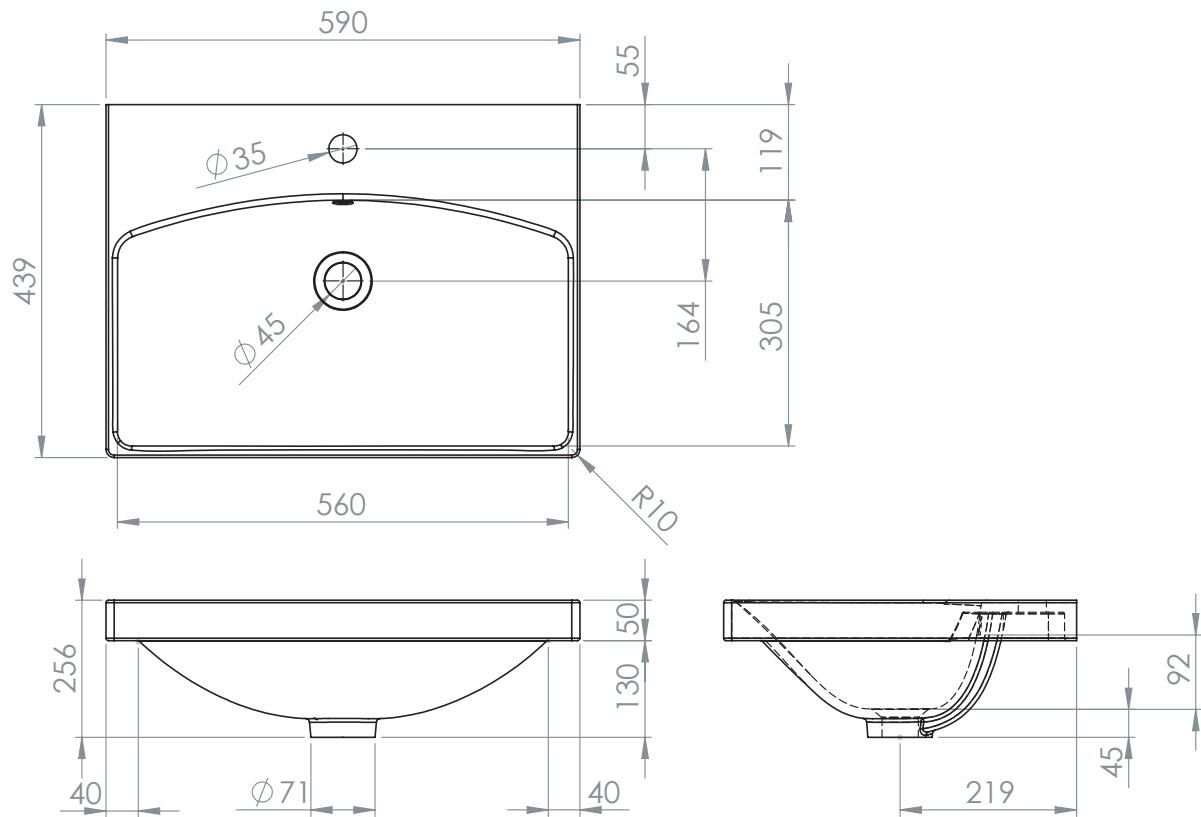

Materials

Basin: Ceramic

Diagrams not to scale
All dimensions in mm
tolerance of +/-5mm

*Dimensions are subject to change, customers are advised to measure actual product before commencing installation.

**Fixing point dimensions are for guidance only/the positions of wall fixing must be checked when product is received.

FAQs

- | | |
|---|--|
| Q: What is the maximum water depth of the basin? | A: 92mm up to the overflow. |
| Q: What is the internal depth? | A: The internal depth is 140mm. |
| Q: Whats is the width of the Tapledge? | A: The Tapledge is 119mm wide. |
| Q: Are fixings supplied? | A: No. |
| Q: What is the distance from the Taphole centre to Basin Waste? | A: 164mm |
| Q: Does the basin have an overflow? | A: Yes. An intergrated overflow. |
| Q: What are the taphole/ basin waste sizes? | A: All sizes are to British Standard - (BS EN 31) <ul style="list-style-type: none">• Diameter of the central tap hole = 35mm : +2/ -1mm• Bore of the waste outlet hole = 46mm : +2 / - 3mm• Diameter of the base for the seal between the waste outlet hole and the waste fitting = ≥ 60 mm |